

LEMC-S-2110 inline - Dimensional drawing

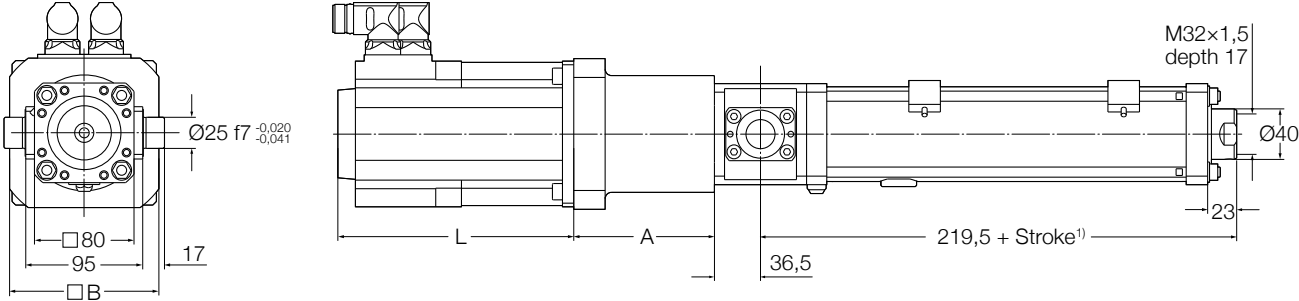

Reference	L ²⁾ mm	A	B
L10LA1	188	112	120
L10LA2	188	112	120
L10LA3	228	112	120
L10LA4	228	112	120
L10LA7	268	112	120
L10LA8	268	112	120

¹⁾ Add 30 mm for anti-rotation option

²⁾ For brake option add 20 mm. For absolute encoder option add 49 mm

LEMC-S-2110 parallel - Dimensional drawing

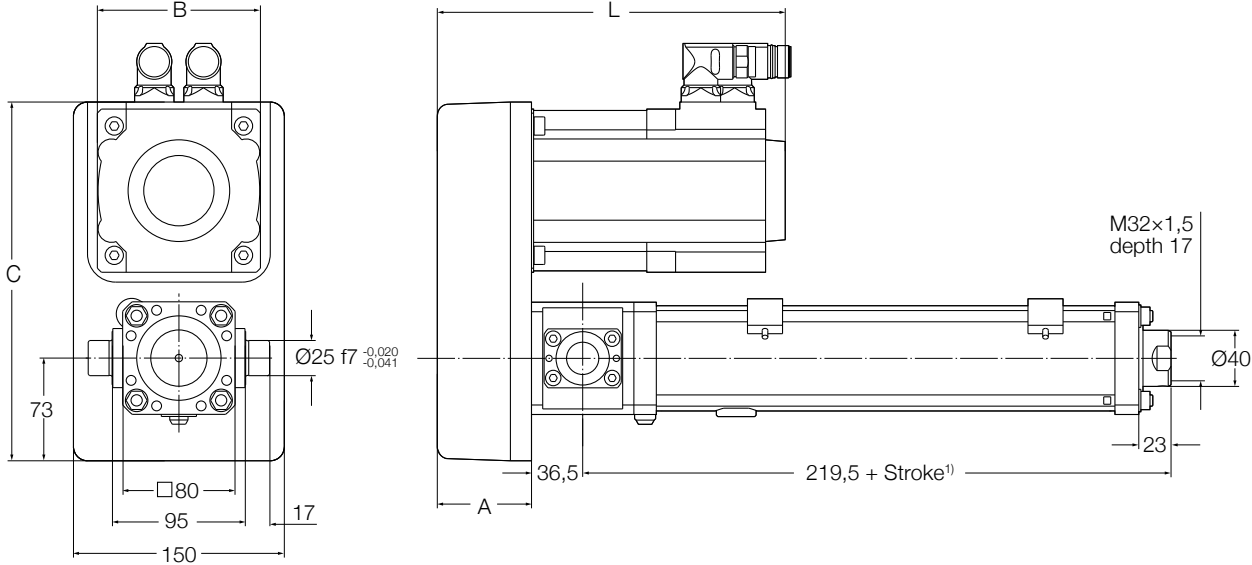

Reference	L ²⁾ mm	A	B	C
P10LA1	247,5	67	116	255
P10LA2	247,5	67	116	255
P10LA3	287,5	67	116	255
P20LA3	287,5	67	116	255
P10LA4	287,5	67	116	255
P20LA4	287,5	67	116	255

¹⁾ Add 30 mm for anti-rotation option

²⁾ For brake option add 20 mm. For absolute encoder option add 49 mm