

# EWELLIX

A Schaeffler Company

INSTALLATION, OPERATION AND MAINTENANCE MANUAL

## LIFTKIT-OM

**OMRON**



# Contents

<b>1. General information</b> .....	<b>3</b>	<b>9. Appendix</b> .....	<b>24</b>
1.1 Information in this manual .....	3	9.1 Safety SCU control unit .....	24
1.2 Explanation of symbols and signal words .....	3	9.2 Use .....	24
1.3 LIFTKIT designations .....	4	9.2.1 Intended Use .....	24
1.4 Related documents .....	4	9.2.2 Unintended Use .....	25
1.5 Target audience .....	4	9.2.3 Essential performance .....	25
<b>2. Safety</b> .....	<b>5</b>	9.3 Responsibility of the owner and processor .....	25
2.1 Intended use .....	5	9.3.1 Areas of responsibility .....	26
2.2 Safety elements .....	5	9.4 Personnel requirements .....	26
2.3 Safety mechanisms .....	5	9.4.1 Qualifications .....	26
2.4 Application notes .....	5	9.5 Specific dangers .....	27
2.5 Potential risks .....	6	9.5.1 Residual hazards to people, objects	
2.6 E-Stop setup and behavior .....	6	and property .....	27
<b>3. LIFTKIT components</b> .....	<b>7</b>	9.5.2 Specific dangers SCU with batteries .....	28
3.1 Scope of delivery .....	7	9.6 Safety equipment .....	28
<b>4. Mechanical installation</b> .....	<b>8</b>	9.7 Safeguard against restart .....	28
4.1 Tools required .....	8	9.8 Modification & Information of device .....	29
4.2 LIFTKIT mechanical setup .....	8	9.8.1 Warning labels .....	29
<b>5. Initialization of LIFTKIT</b>		9.8.2 Information labels & lights .....	29
<b>and robot installation</b> .....	<b>9</b>	9.9 Manufacturer's declaration of EMC compliance .....	31
<b>6. Hardware connection SBOX</b> .....	<b>10</b>	9.9.1 Instructions for use .....	31
6.1 Hardware connection SBOX .....	10		
6.2 Safety connection .....	10		
6.3 LIFTKIT connection setup .....	11		
<b>7. Software instruction for Ewellix LIFTKIT Component</b>			
<b>for TMflow</b> .....	<b>12</b>		
7.1 Introduction .....	12		
7.2 Installation .....	12		
7.3 Command Component .....	14		
7.4 Error Codes .....	18		
7.5 Software update SBOX .....	19		
7.6 SBOX IP address setting .....	20		
<b>8. Specifications</b> .....	<b>22</b>		

**⚠ WARNING**

Please read this manual before installing, operating or maintaining this lifting column. Failure to follow safety precautions and instructions could cause lifting column failure and result in serious injury, death or property damage. Keep this manual nearby for future reference.

# 1. General information

## 1.1 Information in this manual

This manual provides important information on how to work with the actuator (also called device or drive) safely and efficiently.

The manual is part of the device, must always be kept in the device's direct proximity and should be available for personnel to read at any time. All personnel working with the device must read and understand this manual before starting any work. Strict compliance with all specified safety notes and instructions is a basic requirement for safety at work.

Moreover, the accident prevention guidelines and general safety regulations applicable at the place of use of the device must also be complied with.

For a better representation of the circumstance of use, the illustrations used are not necessarily to scale and may vary from the actual design of the device.

## 1.2 Explanation of symbols and signal words

### Safety precautions

Safety precautions are identified by symbols and signal words as shown to the right. The signal words indicate the severity of the hazard and the chance it could occur.

Follow these safety precautions and act cautiously in order to avoid accidents, personal injury and damage to property.

These installation instructions describe the setup and operation of LIFTKIT, a vertical lifting axis for collaborative robots.

### Warning label



The box contains hazardous voltage. Disconnect the power before opening the box.



Do not touch or change any wiring inside the box, except it is stated in this manual.

#### ⚠ DANGER

Indicates a dangerous situation, which will lead to death or serious personal injury, if the precautionary measures are ignored.

#### ⚠ WARNING

Indicates a dangerous situation, which can lead to minor or moderate injury or property damage, if the precautionary measures are ignored.

#### ⚠ CAUTION

Indicates a dangerous situation, which can lead to minor or moderate injury if the precautionary measures are ignored.

#### NOTICE

Indicates information considered important, but not hazard-related (e.g. messages relating to property damage).

#### NOTE

Emphasizes useful hints and recommendations as well as information for efficient and trouble-free operation.

### 1.3 LIFTKIT designations

LIFTKIT contains a lifting column, a controller and additional accessories enabling easy integration with a collaborative robot. Depending on LIFTKIT typekey chosen, different configurations of these included products are possible.

### 1.4 Related documents

This instruction manual does not replace the operating manuals of the included products, but adds additional instructions relevant to the setup and operation of the LIFTKIT's system related to collaborative robots.

For general information and safety instructions please refer to installation, operation and maintenance manuals available at [www.ewellix.com](http://www.ewellix.com).

- TC-08023-EN-May 2020 THG-TLG-TLT operating manual
- TC-08005-EN-March 2020 SCU operating manual

### 1.5 Target audience

This manual is intended for qualified technical personnel who install and use LIFTKIT in their application. This manual and the corresponding operating manuals should be kept available for reference at all times.

Qualified personnel is able to carry out assigned work and to recognize and prevent possible dangers self-reliantly due to its professional training, knowledge and experience as well as profound knowledge of applicable regulations.

### Ordering key



**Robot**  
OM Omron

**Stroke**

	Stroke	Retracted length	Extended length
500	500 mm	525 mm	1 025 mm
600	600 mm	575 mm	1 175 mm
700	700 mm	625 mm	1 325 mm
800	800 mm	675 mm	1 475 mm
900	900 mm	725 mm	1 625 mm
A00	1 000 mm	775 mm	1 775 mm
B00	1 100 mm	825 mm	1 925 mm
C00	1 200 mm	875 mm	2 075 mm
D00	1 300 mm	925 mm	2 225 mm
E00	1 400 mm	975 mm	2 375 mm

**Electrical options**

11	120 V AC / US cable
22	230 V AC / EU cable
23	230 V AC / CN cable
24	230 V AC / UK cable
25	230 V AC / CH cable

**Column type**  
601 TLT

## 2. Safety

This section provides safety aspects supplementary to the safety aspects described in the relevant operating manuals of the included devices. Failure to comply with the guidelines and safety instructions contained in this manual may result in serious hazards that could cause possible serious injury or death, or damage to the device or equipment.

The listed safety aspects must be reviewed and taken into account in the final application risk assessment prior to the use of LIFTKIT.

For more information on safety, see chapter [9 Appendix, 9.1 Safety SCU control unit](#).

### 2.1 Intended use

LIFTKIT has been designed and built for the intended use as described in the operating manual of the column, with additional intended use defined as:

Lift a robot in push-configuration up to the specified force.

Any use that extends beyond the intended use or a use different than the one described above is deemed misuse.

Any type of claims resulting from damage caused by misuse are excluded.

### 2.2 Safety elements

The LIFTKIT has a range of safety elements built in to allow its integration into a robot application, including safety relays certified according ISO 13849-1, allowing Safe Torque Off (STO) up to PLe, Cat. 4.

### 2.3 Safety mechanisms

The following measures have been integrated in LIFTKIT to reduce the risk of harm or damage:

- The individual components have been designed and UL certified according to IEC 60601-1 – Safety of medical devices. The SBOX has been designed according to EN ISO 13849.
- The column has an integrated mechanical brake that prevents back-driving of the column in case of power loss or motor failure.
- A backup nut is installed to prevent a sudden collapse of the column in case of failure or wear of the nut.
- Pinching risk between the tube sections of the column and the Omron attachment plate is minimized. In retracted position, the minimum gap is 40 mm.
- The LIFTKIT's SCU controller and the SBOX have to be connected to the Omron safety I/O connection to operate. Activation of the Omron emergency stop will trigger a stop of the LIFTKIT's SCU controller and the SBOX.
- Stopping or failure of the Omron software triggers a stop signal to the LIFTKIT's controller.

### 2.4 Application notes

The following application notes have to be followed:

- Integration with an emergency-stop is required for its intended use.
- Install emergency stop functions for the column and integrate them into the safety chain of the complete system prior to operating LIFTKIT.
- The emergency stop function has to be connected in such a way that a disruption of the power supply or the activation of the power supply after a power disruption cannot cause a hazardous situation for persons and objects.
- The emergency-stop systems must always be freely accessible.

To integrate LIFTKIT into a functional safety system with a STO safe condition, the SBOX has to be connected to the Omron safety I/O.

## 2.5 Potential risks

The following risks during LIFTKIT operation have to be considered in an application specific risk assessment:

- The column does not detect an impact automatically and does not stop movement upon impact. This can lead to:
  - Crushing of a person or an object in the path of the column, causing serious injury or death or property damage.
  - Dynamic impact to a person or an object causing serious injury or death or property damage.
- It is possible that the column movement does not stop at the desired position
  - Movement of the robot can occur at a different position than intended, causing significant serious injury or death or property damage. Movement of the robot can occur at a different position than intended, causing significant serious injury or death or property damage.

## 2.6 E-Stop setup and behavior

The LIFTKIT has two e-stop mechanisms. One is integrated into the SBOX, the other directly into the SCU controller. The SCU controller mechanism is software controlled and is much faster, but only the SBOX mechanism guarantees a STO up to PLe, Cat.4. It is recommended to integrate both mechanisms into the safety system. The **table 1** compares both E-Stop mechanisms.

**Table 1**

E-Stop mechanism	Performance level ISO 13489-1	Stop distance	Stop time
SCU	Not rated	18 mm	200 ms
SBOX	Up to PLe, Cat. 4	28 mm	750 ms

## 3. LIFTKIT components

### 3.1 Scope of delivery

The following enumerated parts are delivered and are depicted in **figure 1**.

- 1 Lifting column TLT
- 1 Control unit SCU16/56/96
- 1 SBOX power cable EU/US/CH/CN
- 1 RS232 interface cable M/0133976
- 1 Controller I/O cable M/0133975
- 1 EHA3A operating handswitch
- 1 Omron attachment plate
- 1 bottom mounting plate
- 8 M10x40 screws for mounting plates (1)
- 4 screws M6x20 for Omron robot (2)
- 2 pins Ø 8x20 to align Omron robot (3)
- Quick start guide
- 1 SBOX
- 1 SBOX key
- 1 SBOX I/O cable
- 1 SBOX to controller power cable
- 1 Ethernet cable
- SBOX mounting attachments

Figure 1

Scope of delivery

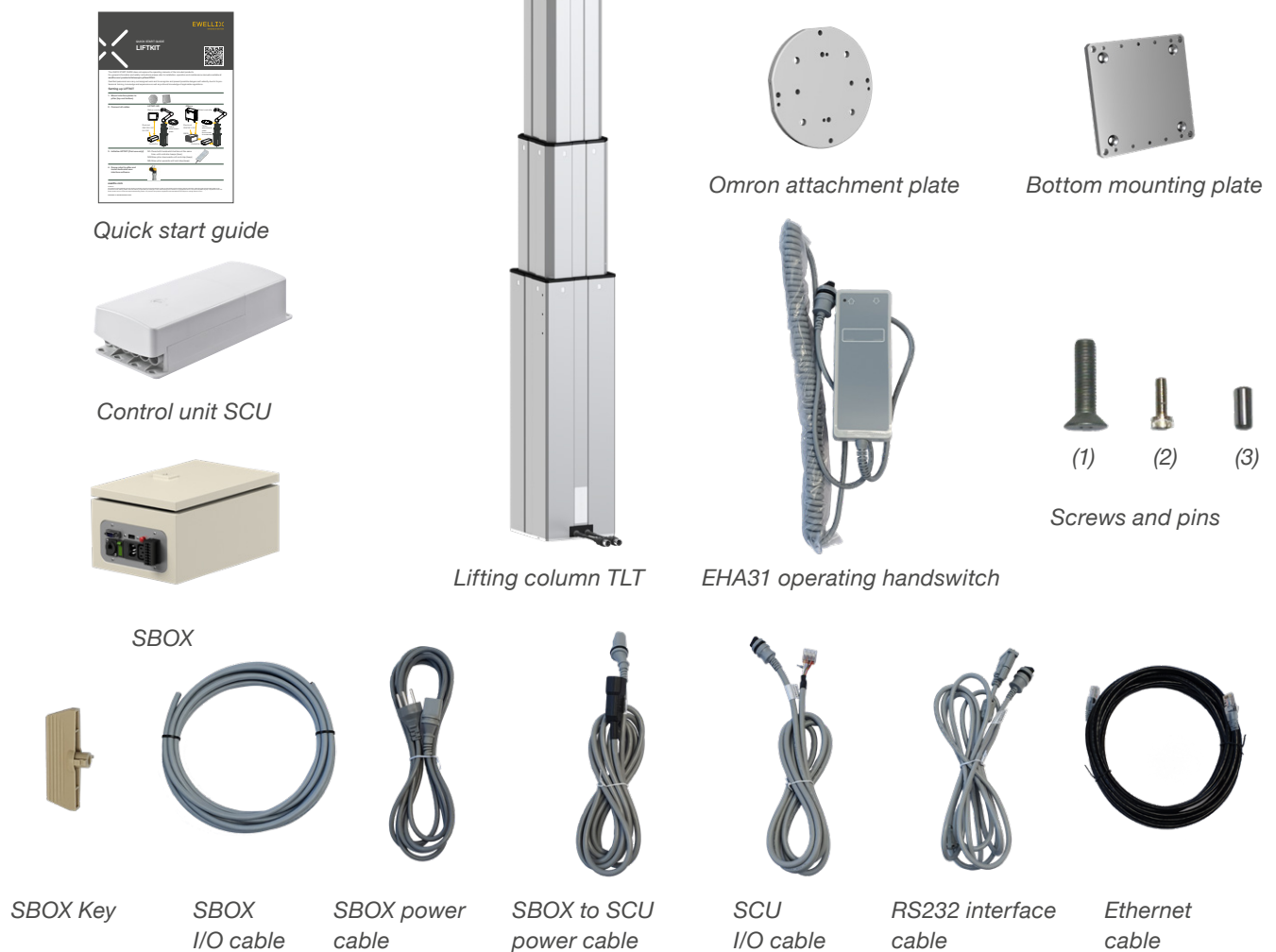

# 4. Mechanical installation

## 4.1 Tools required

The following tools are required for the mechanical installation:

- Hex key size 5 and 6
- Screw driver 2 mm

## 4.2 LIFTKIT mechanical setup

Refer to the numbers in section [3.1 Scope of delivery](#), and in the **figure 2** for the preparation of the lifting column:

1. Take the lifting column out of the box.
2. Loosen and remove 4 transport screws (1) at the bottom of the lifting column.
3. Attach the bottom mounting plate (2) using 4 M10x40 screws on the outer guiding of the lifting column. Ensure a tightening torque of 40 Nm on these screws.
4. Fix the bottom (2) plate securely to the ground or a frame using at least four ground fixation holes on the plate (3). It is recommended to maintain the outer aluminium profile of the LIFTKIT to increase its stability.

**NOTE**

Alternatively, if mounting to a SLIDEKIT, remove the robot attachment plate from the SLIDEKIT and attach the LIFTKIT bottom plate with 8x M6 screws to the SLIDEKIT attachment plate.

5. Loosen and remove 4 transport screws (1) at the top of the lifting column.
6. Attach the top Omron attachment plate (4) using 4 M10x40 screws on the inner guiding tube.

**Figure 2**

Close up of transport screws (left) and the TLT (right)

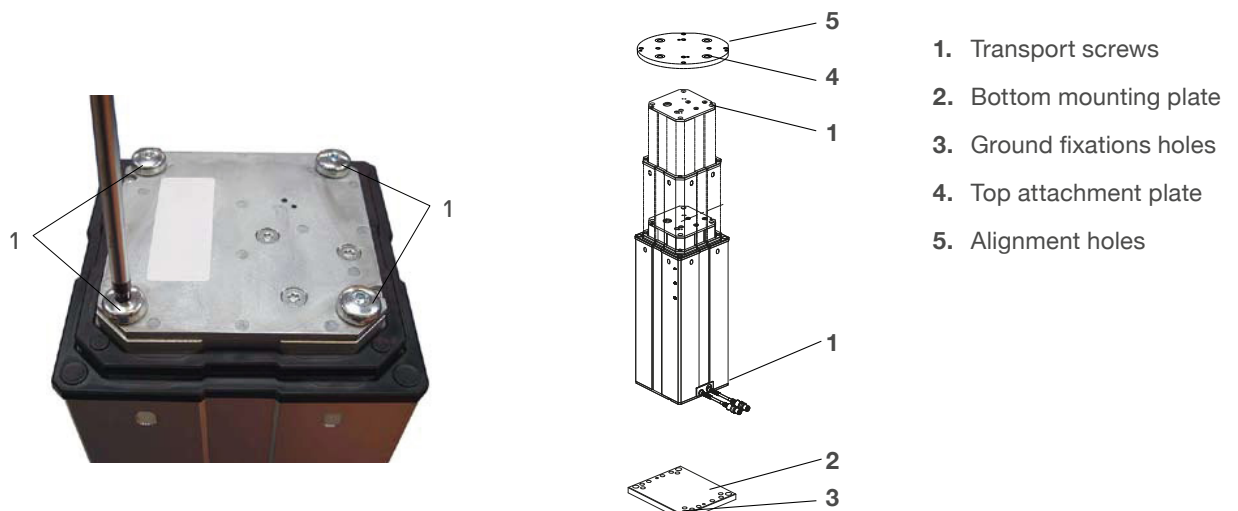



# 5. Initialization of LIFTKIT and robot installation

LIFTKIT must be initialized before its first operation. For this, follow the steps below:

1. Connect the LIFTKIT like the following **figure 3**. It is recommended to do the initialization without the robot mounted on the column. The lifting column has to be plugged into port 1 and 2 of the SCU.
2. Override of the emergency stop link. Short-circuit the three wires with the provided clamp as shown in **figure 4**, in order to override the emergency stop link.
3. Press both handswitch buttons simultaneously for about 5 seconds, until the SCU rattles and beeps. Now the column will run at 50% speed and force.
4. With the help of the handswitch and the buttons move the column downwards until it hits the end position. The SCU controller beeps.
5. With the help of the handswitch and the buttons move the column upwards to the top position until it hits the end position. The SCU controller beeps.

**NOTE**  
If the system connections are changed, a new initialization may be required.

6. If required, insert the 2 alignment pins on the top plate and press them in (or use a plastic hammer).
7. Align the robot with the alignment pins and fix the robot base with the four screws provided.
8. Undo the temporary emergency stop override from step 2.

**Figure 4**

*Zoom on the safety I/O cable to override emergency stop link with provided clamp*

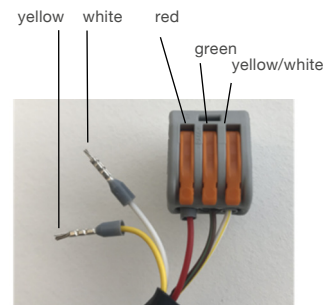

**Figure 3**

**NOTE**  
The identified end positions are used as virtual limits, which will be approached by soft ramps. After successful initialization the lifting column will move at full speed and full force. If it does not reach its full stroke or continues to beep, then repeat the initialization procedure again.

*Digital I/O clamp in robot controller*

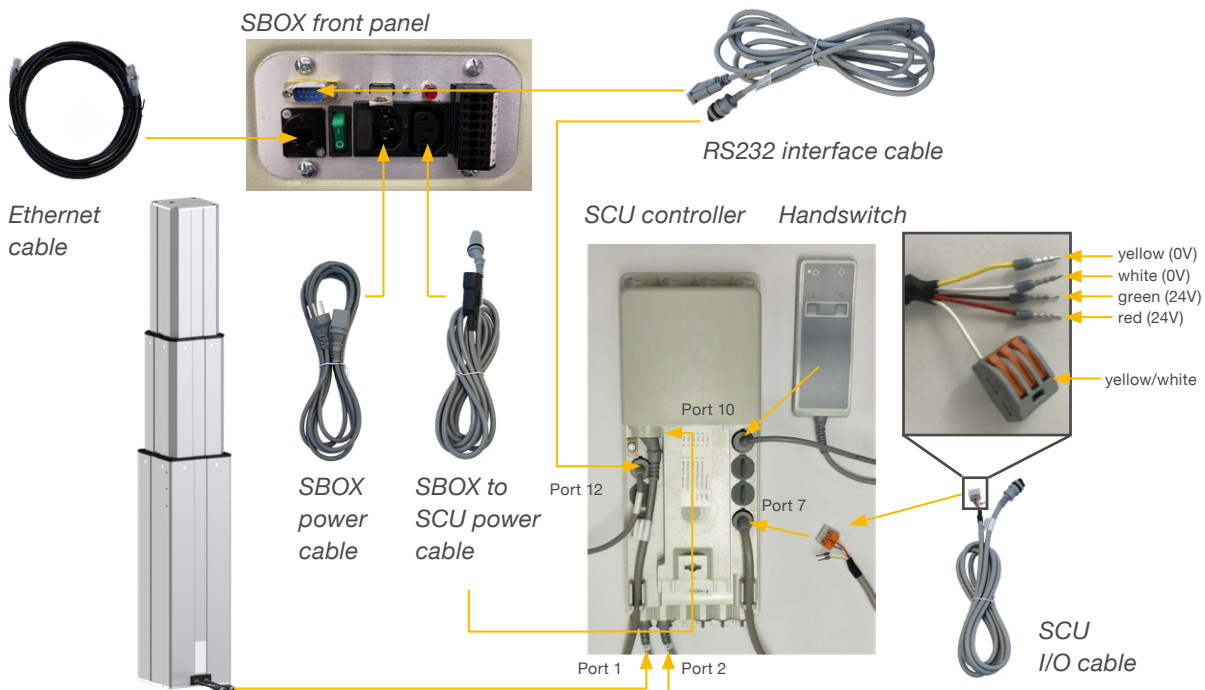

# 6. Hardware connection SBOX

## 6.1 Hardware connection SBOX

The SBOX is used to interface with the SCU and the robot controller. **Figure 6** gives a view on the front panel of the SBOX, whereas **figure 5** gives a detailed look on the electrical connections for the safety relays.

Figure 5



- 1. K1.A1 → 24V for safety relay #1
- 2. K2.A1 → 24V for safety relay #2
- 3. K1.A2 → 0V for safety relay #1
- 4. K2.A2 → 0V for safety relay #2
- 5. K1.31 → read out for relay #1
- 6. K1.32 → read out for relay #1
- 7. K2.31 → read out for relay #2
- 8. K2.32 → read out for relay #2

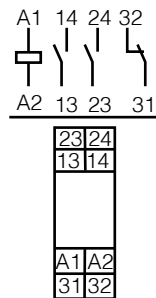
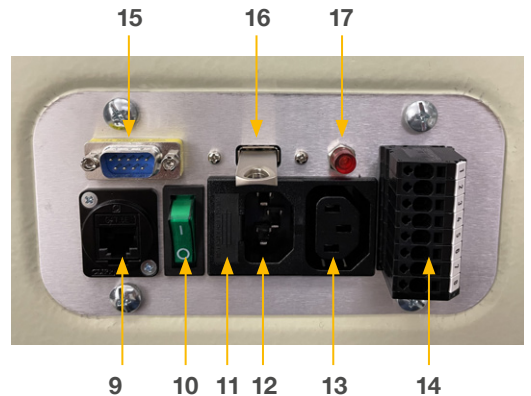

Figure 6



- 9. Ethernet connector
- 10. On/Off switch
- 11. Fuse
- 12. Power In
- 13. Power Out
- 14. I/O connector
- 15. RS232 connector
- 16. USB port
- 17. Relays status light (if On relays are powered)

## 6.2 Safety connection

The SBOX has two integrated safety relays with forcibly guided contacts. Their coil and feedback contacts are wired directly to the I/O connector and is shown in **figure 5**.

### 6.3 LIFTKIT connection setup

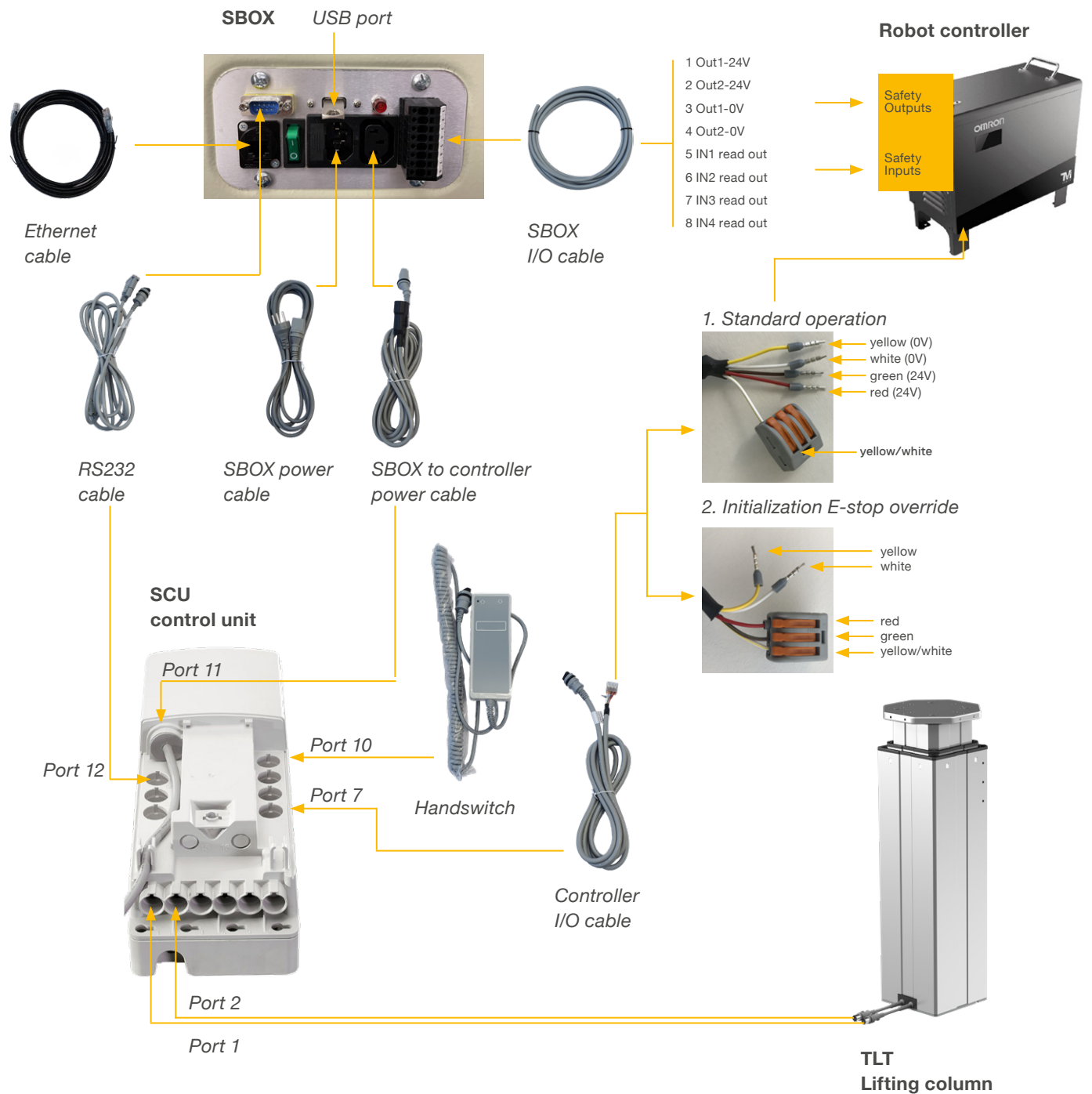

# 7. Software instruction for Ewellix LIFTKIT Component for TMflow

## 7.1 Introduction

The Ewellix LIFTKIT component allows customers to integrate the LIFTKIT tilting column's capabilities with TMflow applications. Currently, there is only one component available for LIFTKIT integration: **Command**.

## 7.2 Installation

Download the zipped component file from the Ewellix website: [www.ewellix.com/en/support/media-library](http://www.ewellix.com/en/support/media-library) → **Software updates** → **LIFTKIT** or by scanning the QR code below.



QR code to the Ewellix Media library.

1. Take the zipped component file and place it into a TMROBOT-formatted USB drive or a network drive that is mapped to the robot's Network Service feature.

- 1.1 For the USB stick to be in TMROBOT format, it needs to be on the NTFS file system and named TMROBOT (all-caps) (see **figure 7**).

Figure 7

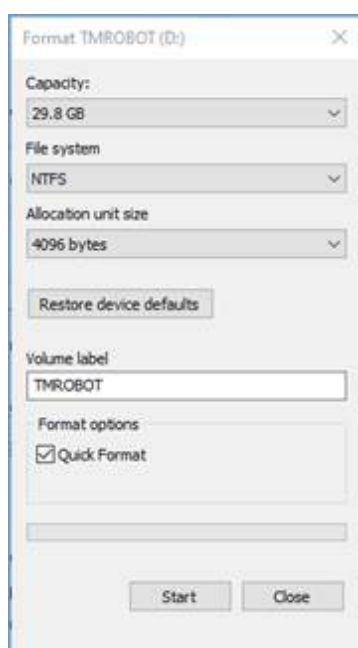

- 1.2 The Network Service feature looks like **figure 8**.

Figure 8

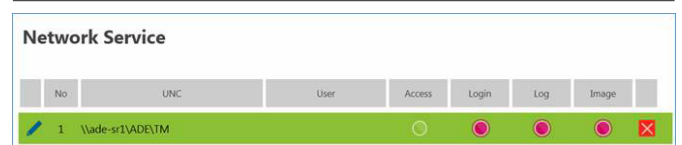

2. In the drive of your choosing, place the zipped component file into a directory that looks like this, for example: **D:\TM\_Export\RobotName\ComponentObject\Column\_Ewellix\_LIFTKIT\_v01\_Command.zip**
  3. Open the Import/Export menu in TMflow, then plug the USB drive into the robot controller or select the network drive (see **figure 9**).

Figure 9

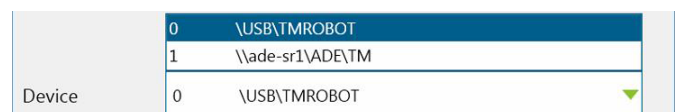

4. Select **Import**, then select the correct Robot ID. In the example in **figure 10**, the robot ID is simply, **RobotName** based on the directory above.

Figure 10

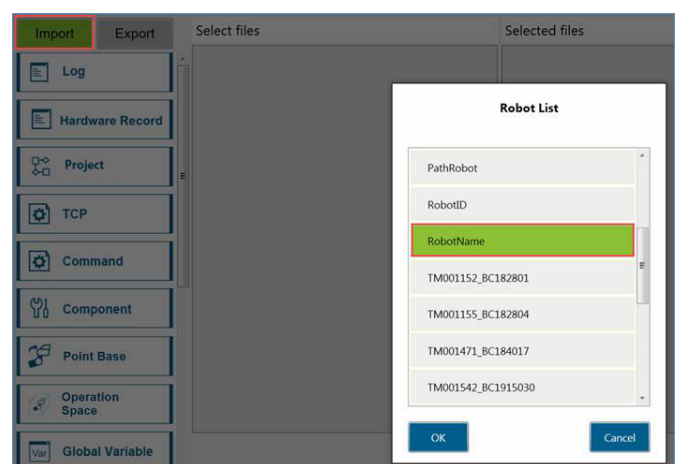

5. Select **Component**, then click on the Ewellix column component, then click **Import** (see **figure 11**).

Figure 11

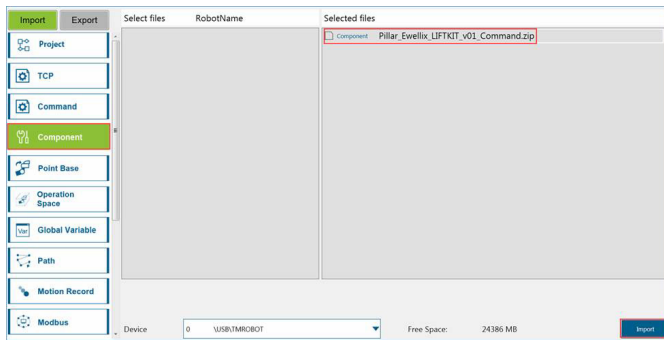

6. Go to the Component menu in the robot settings page, then enable the Ewellix component. Click **Save** when done (see **figure 12**).

Figure 12

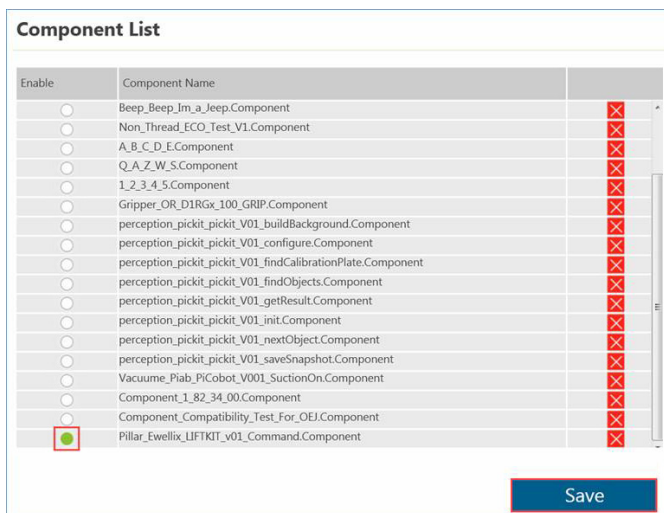

7. Now the component is ready for drag-and-drop use with TMflow projects! (see **figure 13**).

Figure 13

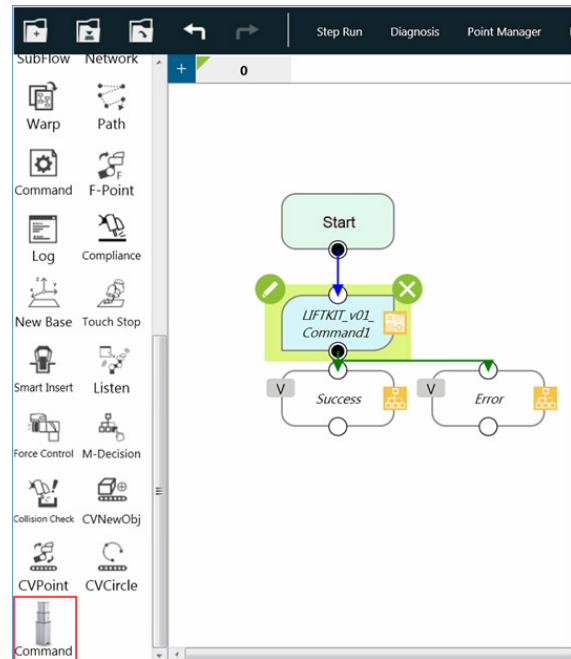

## 7.3 Command Component

The Command component has four primary functions, each performed in the order listed:

1. Specify Column IP Address (does not reconfigure the column's IP).
2. Get Column Info (such as current status, current virtual limits, and current position).
3. Set Column Info (such as column type and virtual limits).
4. Move the Column to an absolute position.

Figure 14

**Command Component & Icon** – Column Ewellix LIFTKIT v01 TestProject

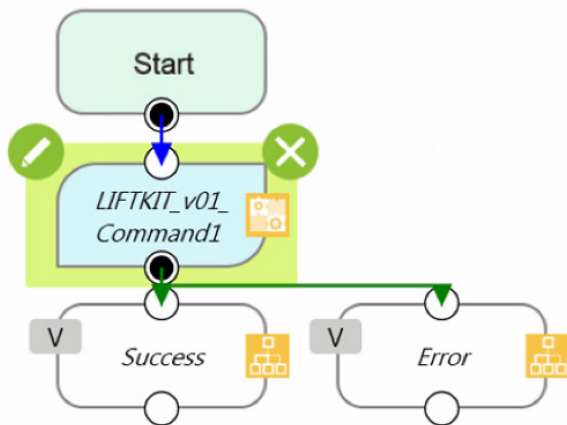
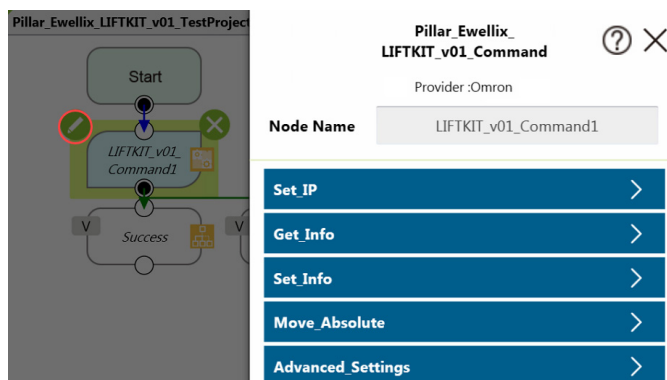

Figure 15

User Input Menu



### Set\_IP

Figure 16

Set\_IP Settings

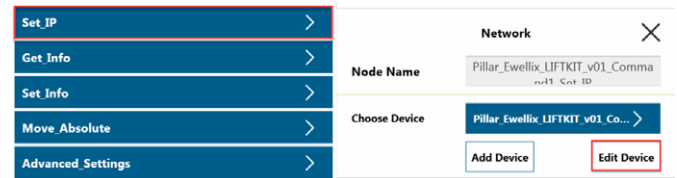

In this menu, click **Edit Device** to adjust the IP address and port settings of the LIFTKIT.

**NOTE**

DO NOT select Add or Choose a different device, as this will cause the component to fail.

**NOTE**

The default IP address of the component matches the default IP address that the LIFTKIT uses out-of-the-box. This menu should only be needed if the LIFTKIT IP address has been reconfigured by the user.

### Get\_Info

Figure 17

Get\_Info Settings



**var\_GetInfo:**

- **Function:** Determines whether the component will request information from the column using the **Get** commands such as *get\_position* and *get\_type*.
- **Type:** Boolean variable
- **Default:** true

**NOTE**

If set to true, this is the first step that the component will perform. This means that the information gathered during this step will be snapshotted before any **Set** commands or motion commands are issued.

## Set\_Info

Figure 18

### Set\_Info Settings

Set_IP	>	Pillar_Ewellix_LIFTKIT_v01_Command1 = false
Get_Info	>	bool_Pillar_Ewellix_LIFTKIT_v01_Command1_var_SetVirtualLimits
Set_Info	>	Pillar_Ewellix_LIFTKIT_v01_Command1 = 0
Move_Absolute	>	float_Pillar_Ewellix_LIFTKIT_v01_Command1_var_LowerLimit
Advanced_Settings	>	Pillar_Ewellix_LIFTKIT_v01_Command1_var_UpperLimit = 700
		bool_Pillar_Ewellix_LIFTKIT_v01_Command1_var_SetType = false
		Pillar_Ewellix_LIFTKIT_v01_Command1_var_Type = "LIFTKIT-601"

#### var\_SetVirtualLimits:

- **Function:** Determines whether the component will modify the column's current virtual limits settings using the `set_virtualLimits` command.
- **Type:** Boolean variable
- **Default:** false

#### var\_LowerLimit:

- **Function:** Sets the lower virtual limit used in the `set_virtualLimits` command.
- **Type:** Float variable
- **Default:** 0

#### var\_UpperLimit:

- **Function:** Sets the upper virtual limit used in the `set_virtualLimits` command.
- **Type:** Float variable
- **Default:** 700

#### var\_SetType:

- **Function:** Determines whether the component will modify the column's current type using the `set_type` command. If set to true, this will require both the column and communication box to be power cycled for the changes to take effect, and the component will exit immediately after the type is set.
- **Type:** Boolean variable
- **Default:** false

#### var\_Type:

- **Function:** Sets the value of the column type that will be set once the `set_type` command is issued. Use the `get_typeAvailable` command in the `Get Info` function of the component for a list of acceptable column types.
- **Type:** String variable
- **Default:** "LIFTKIT-601"

## Move\_Absolute

Figure 19

### Move\_Absolute Settings

Set_IP	>	Pillar_Ewellix_LIFTKIT_v01_Command1 = false
Get_Info	>	bool_Pillar_Ewellix_LIFTKIT_v01_Command1_var_MoveAbsolute
Set_Info	>	Pillar_Ewellix_LIFTKIT_v01_Command1 = 0
Move_Absolute	>	float_Pillar_Ewellix_LIFTKIT_v01_Command1_var_AbsolutePosition
Advanced_Settings	>	Pillar_Ewellix_LIFTKIT_v01_Command1_var_MoveTimeout = 10000

#### var\_MoveAbsolute:

- **Function:** Determines whether the component will issue the `moveTo_absolutePosition` command to the column.
- **Type:** Boolean variable
- **Default:** false

#### var\_AbsolutePosition:

- **Function:** Sets the absolute position to which the column will move when issued the `moveTo_absolutePosition` command.
- **Type:** Float variable
- **Default:** 0

#### var\_MoveTimeout\_ms:

- **Function:** Sets the amount of time in ms for the column to reach its commanded position before timing out.
- **Type:** Integer variable
- **Default:** 10000

## Advanced\_Settings

Figure 20

### Advanced Settings

Set_IP	>	Pillar_Ewellix_LIFTKIT_v01_Command1 = 20
Get_Info	>	float_Pillar_Ewellix_LIFTKIT_v01_Command1_var_PositionTolerance
Set_Info	>	Pillar_Ewellix_LIFTKIT_v01_Command1 = 50
Move_Absolute	>	int_Pillar_Ewellix_LIFTKIT_v01_Command1_var_WaitTime_ms
Advanced_Settings	>	Pillar_Ewellix_LIFTKIT_v01_Command1_var_MaxRec = 50

#### var\_Position\_Tolerance:

- **Function:** Sets the maximum allowable difference between the column's commanded position and its actual position once its motion is complete.
- **Type:** Float variable
- **Default:** 20 (units are in mm)

**var\_WaitTime\_ms:**

- **Function:** Sets the wait time in milliseconds. Wait time is the amount of delay time required between each serial command sent from TMflow to the column. In newer versions of TMflow, this is referred to as **Extra Idle Time**.
- **Type:** Integer variable
- **Default:** 50 ms

**var\_MaxReceiveTime\_ms:**

- **Function:** Sets the maximum receive data time in milliseconds. Max receive time is the amount of time TMflow will wait for data to be received in the buffer for reading before timing out.
- **Type:** Integer variable
- **Default:** 50 ms

**Imported Variables**

Figure 21

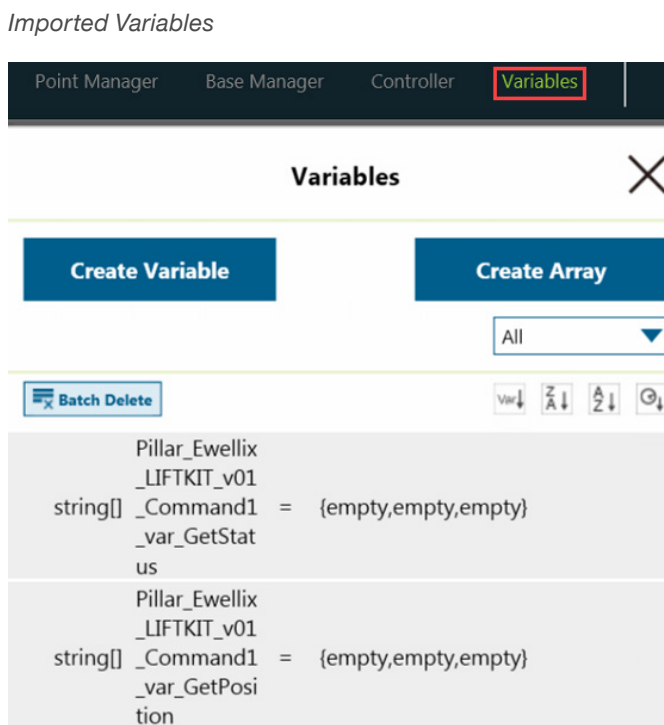

**var\_GetStatus:**

- **Function:** Reports the current status of the LIFTKIT, used in all three functions of Get\_Info, Set\_Info, and Move\_Absolute. If multiple functions are used in one component instance, then the value of GetStatus will be overwritten multiple times.
- **Type:** String Array

**var\_GetPosition:**

- **Function:** Reports the current absolute position of the LIFTKIT.
- **Type:** String Array
- **Default:** empty

**var\_GetStroke:**

- **Function:** Reports the maximum stroke of the LIFTKIT unit.
- **Type:** String Array
- **Default:** empty

**var\_GetVirtualLimits:**

- **Function:** Reports the currently configured virtual upper and lower limits for the LIFTKIT.
- **Type:** String Array
- **Default:** empty

**var\_GetType:**

- **Function:** Reports the currently configured LIFTKIT type. If the reported LIFTKIT type is different from what the actual LIFTKIT unit should be, then this can be reconfigured using the Set\_Type command within the Set\_Info function.
- **Type:** String Array
- **Default:** empty

**var\_GetTypesAvailable:**

- **Function:** Reports the available types of the LIFTKIT that can be used with the Set\_Type command. If the purchased LIFTKIT unit's type does not exist in this list, please contact Ewellix customer support.
- **Type:** String Array
- **Default:** empty

**var\_ErrorCode:**

- **Function:** The error code that is output when there is an error (see [7.4 Error Codes](#))
- **Type:** Integer variable, ranges from 4000-4005 (or 0 if there is no error)
- **Default:** 0

**var\_PreviousPosition:**

- **Function:** If the Move\_Absolute function is used, this variable will store the LIFTKIT's current absolute position before moving to the commanded position.
- **Type:** Float variable
- **Default:** 0



## Typical Usage

### Initial Installation and Testing

Upon the installation of the column with the TM robot, the Command component should be used by itself in an empty project to troubleshoot any connection issues and to test if the commands are working. Use the following steps to get the column running:

1. Create a new project and drag-and-drop the component into the flow.
2. If the column's IP address has been changed from the default, specify the new IP address in the component.
3. Run the project with the *Get\_Info* function set to **true** and the other functions set to **false** (this is the default configuration of the component).
  - a. If there is an Error Code displayed, follow the error code troubleshooting tips and repeat Step 3 until the column gives a response (see [7.4 Error Codes](#)).
  - b. If there is a response from the column other than **READY**, the connection to the column was successfully established, but further action is required based on the response given. Depending on the column's current state, it may be possible to issue the *set\_type* and *set\_virtualLimits* commands with the component. Refer to the Ewellix LIFTKIT manual for more details on the available LIFTKIT commands, allowed states, and responses. After each troubleshooting step, repeat Step 3.
  - c. If the response from the column is **READY**, then it is now possible to send it motion commands.
4. If needed, use the *Set\_VirtualLimits* command to set the appropriate virtual limits of the column.
5. Test the column's motion by using the *Move\_Absolute* function to command the column to various positions within the range of the virtual limits.

### Regular Operation

The component can be used multiple times throughout a TMflow project to get the current column status via the *Get\_Info* function or to send the column motion commands with the *Move\_Absolute* function. The relevant imported variables will be updated as the flow moves through the component.

#### NOTE

If the component is used more than once in a project for one LIFTKIT device, then the **Inherit old component** option must be selected when dragging and dropping each component after the first one into flow. This is because the LIFTKIT cannot accept multiple connections to the same socket.

#### NOTE

It is not recommended to use the *Set\_Info* function during regular operation unless the virtual limits need to be reconfigured regularly for an application.

## 7.4 Error Codes

Error Code	Name	Description	Troubleshooting
4000	Connection Error	Could not connect to the column when the flow entered the component.	Check the following: <ol style="list-style-type: none"> <li>1. Column is powered on.</li> <li>2. Column is connected to TM control box Ethernet port directly or via an Ethernet hub.</li> <li>3. The correct IP address and port number were selected in the Set_IP settings of the component.</li> </ol>
4001	Connection Timeout	Connection to the column timed out.	The connection was established when the flow entered the component, but the column did not respond to the component commands within the timeout period. Check the following: <ol style="list-style-type: none"> <li>1. No power or communication cables were removed from the column during operation.</li> <li>2. The Set_IP settings are set for the column and not for another device on the network.</li> <li>3. The MaxReceiveTime_ms variable values and WaitTime_ms values are large enough for the column to finish processing and sending the results to the TM.</li> </ol>
4002	Invalid State	Column is in an invalid state for the specified command.	See Ewellix LIFTKIT manual for details.
4003	Error Response Received	Column issued an error response for the specified command.	See Ewellix LIFTKIT manual for details.
4004	Motion Timeout	The motion timeout period was reached before the column could issue the "READY" response to indicate completed motion.	Check the following: <ol style="list-style-type: none"> <li>1. The MoveTimeout_ms value is large enough for the column to complete its motion.</li> <li>2. The column is performing the commanded motion in the expected way and the status of the column is "MOVING" during the motion.</li> </ol>
4005	Position Tolerance Exceeded	The difference between the commanded position and the actual position is greater than the specified Position_Tolerance value.	Check the following: <ol style="list-style-type: none"> <li>1. The Position_Tolerance value is large enough for the column to realistically handle during operation but without hurting the application.</li> <li>2. The column is performing the commanded motion in the expected way.</li> </ol>

## 7.5 Software update SBOX

Software updates can be done by flashing a new image to the controller SD card.

1. Remove all cables attached to the SBOX (see **figure 22**).

**Figure 22**

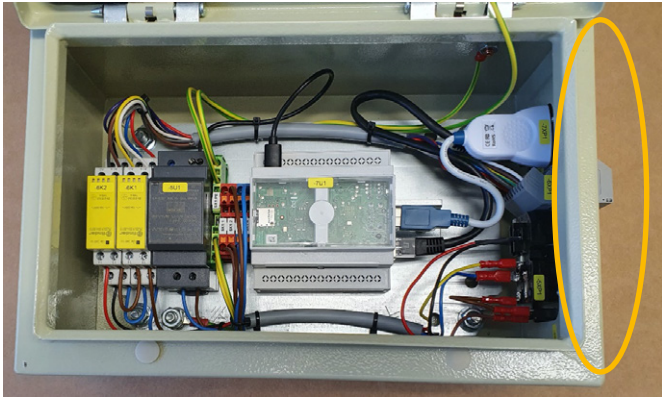

2. Unplug the USB and the ethernet connector from the controller (see **figure 23**).

**Figure 23**

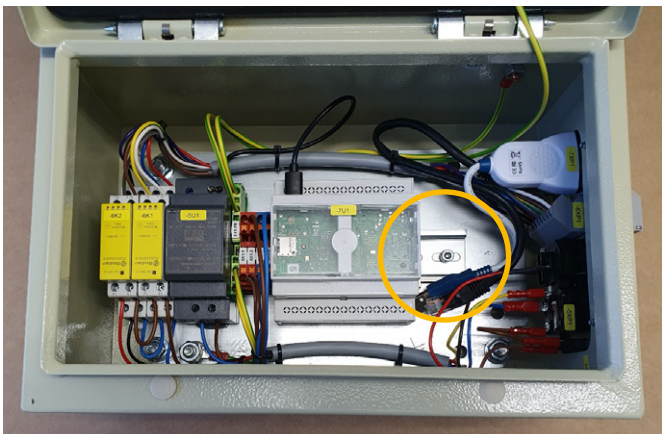

3. Move controller to the front plate (see **figure 24**).

**Figure 24**

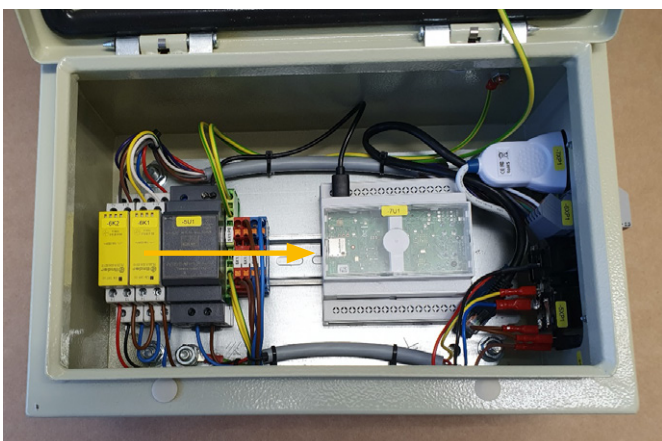

4. Remove the SD card using a small tool like a pliers (see **figure 25**).

**Figure 25**

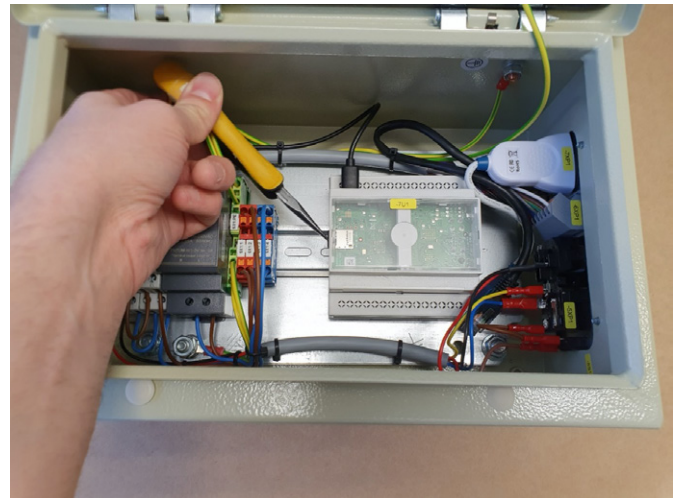

5. Download and install one of these tools:

- Raspberry imager, from <https://www.raspberrypi.org/downloads/>
- balenaEtcher, from <https://www.balena.io/etcher/>

6. Copy Image on SD card:

- 6.1 Place SD card into your laptop
- 6.2 Do not format SD card
- 6.3 Start Raspberry imager or balenaEtcher
- 6.4 Choose Image
- 6.5 Select SD Card
- 6.6 Start writing process

7. Put SD card back into Controller following the steps 1 – 4 in reverse.

## 7.6 SBOX IP address setting

The SBOX uses a static IP address. The default address is 192.168.1.100.

If you need to set a different IP address, please follow the steps listed below:

1. Create a file called `ip_changer.conf` on your PC. We recommend to use the freeware Notepad++ or similar.
2. Insert the following content:  

```
static ip_address=192.168.1.100/24
static routers=192.168.1.1
static domain_name_servers=192.168.1.1
```
3. Change the addresses to your needs. Make sure that the /24 stays behind the static IP address.
4. Make all characters visible (see **figure 26**).

Figure 26

### Show all characters

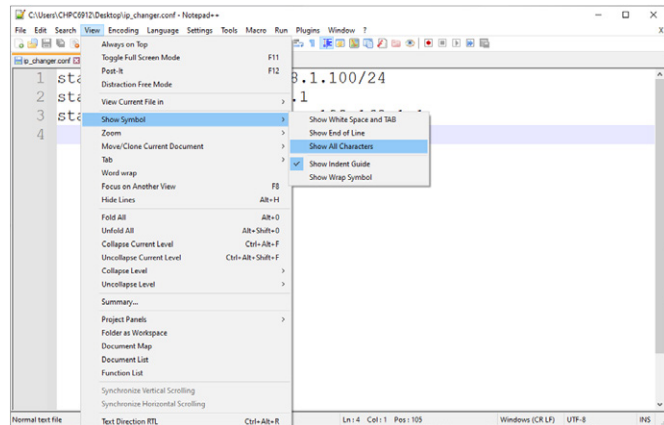

5. Convert the End Of Line into Unix (LF) (see **figure 27**).

Figure 27

### EOL conversion to UNIX (LF) format

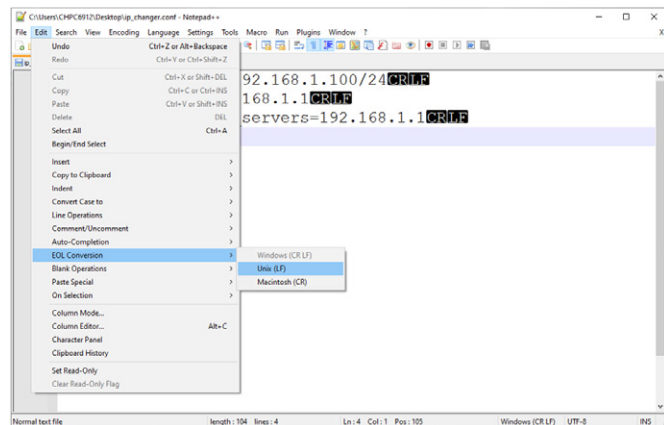

6. Save the file on a USB memory stick previously formatted in FAT32.

If you have a SBOX with an external USB port please continue with these steps:

7. Switch off the SBOX with the switch and make sure the light is no longer on.
8. Insert the USB memory stick into external USB port (see **figure 28**).

Figure 28

Front view on SBOX with external USB port

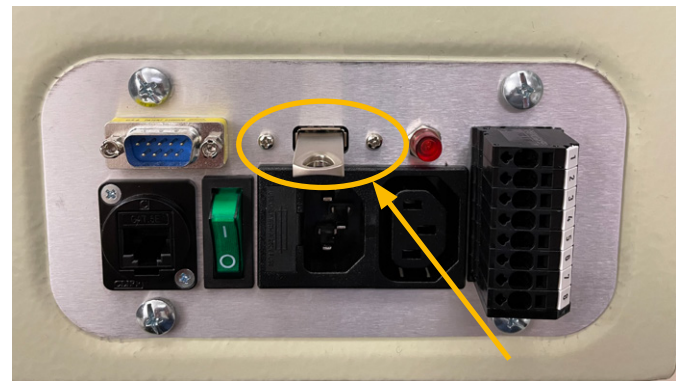

9. Switch on the SBOX with the switch and make sure the light is on.
10. Wait for 5 minutes.
11. Switch off the SBOX with the switch and make sure the light is no longer on.
12. Remove the USB memory stick from the USB port.
13. Switch on the SBOX with the switch and make sure the light is on.
14. The following empty file will be created on the USB memory stick to confirm the IP address change has been successful:

`update_ip_address_successfull_from_"Name of the USB Stick"`

**If you have a SBOX without an external USB port please continue from step 15:**

15. Remove all cables attached to the SBOX.
16. Open the SBOX with the provided key.
17. Insert the USB memory stick into any available USB port of the SBOX controller (see **figure 29**).

**Figure 29**

*Inside view on SBOX without external USB port*

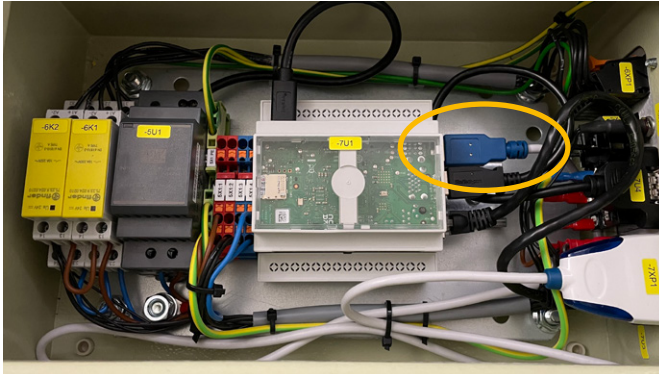

18. Close the SBOX.
19. Plug in the power cable into the SBOX.
20. Switch on the SBOX.
21. Wait for 5 Minutes.
22. Switch off the SBOX.
23. Remove all cables from the SBOX.
24. Open the SBOX.
25. Remove the USB memory stick.
26. Close the SBOX.
27. Connect all cables.
28. The following empty file will be created on the USBmemory stick to confirm the IP address change has been successful:

*update\_ip\_address\_successfull\_from\_"Name of the USB Stick"*

# 8. Specifications

## Operating range extension

- Vertical lifting of the cobot by up to 1 400 mm with compact retracted height
- Robust column design for industrial use, vibration free motion and virtually maintenance free

## Plug-and-play solution

- Hardware interface compatible with TM5, TM12, TM14 and TM20 robots
- Omron certified product
- Software control integrated with TMflow for easy motion programming

## Cost savings and higher productivity

Cobots combined with Ewellix LIFTKIT provide a cost-effective solution to upgrade an existing assembly shop, moving from a manual handled to a fully automatized line.



## Technical data

	Unit	LIFTKIT-OM-601
<b>Column type</b>	-	TLT
<b>Performance Data</b>		
Max. push load	N	1 500
Max. pull load	N	0
Max. dynamic moment	Nm	210
Max. static moment	Nm	3 000
Max. linear speed	mm/s	80
Duty cycle	-	10 % (20 % at 500N)
<b>Mechanical Data</b>		
Screw type	-	Acme screw
Stroke range	mm	500 - 1 400
Retracted length (software controlled)	mm	Stroke/2 + 275
Weight @ 0 mm stroke	kg	21
Δ weight per 500 mm stroke	kg	1,7
Robots compatibility	-	TM5, TM12, TM14, TM20
Cable management	-	Threads on column and interface plate to attach cable management
<b>Electrical</b>		
Input Voltage/Current	-	120 VAC / 6,5 A 230 VAC / 3,3 A
Input frequency	Hz	50-60
Input Fuse	A	10
I/O voltage	-	24 VDC
I/O current	-	max. 10 A not protected
Emergency stop	-	STO up to PLe, Cat.4
<b>Communication</b>		
Control interface	-	TMflow
Positioning, repeatability	mm	± 1
Accessible positions	-	Any
Feedback	-	Position & Status
Soft start and stop	-	Implemented for smooth operation
Software control	-	TMflow software
<b>Environment</b>		
Type of protection	-	IP40
Ambient temperature	°C	+10 to +40
Max. humidity	%	85
Vibration	-	Stationary industrial environment

# Dimensional drawing

## TLT Lifting column

### Robot attachment plate

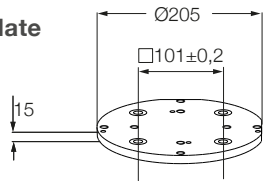

### TLT Column

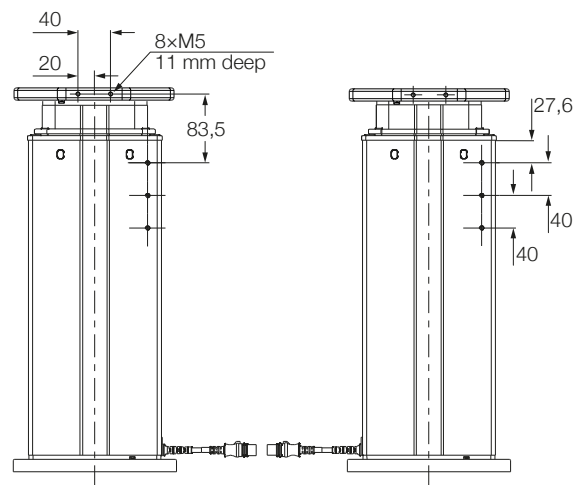
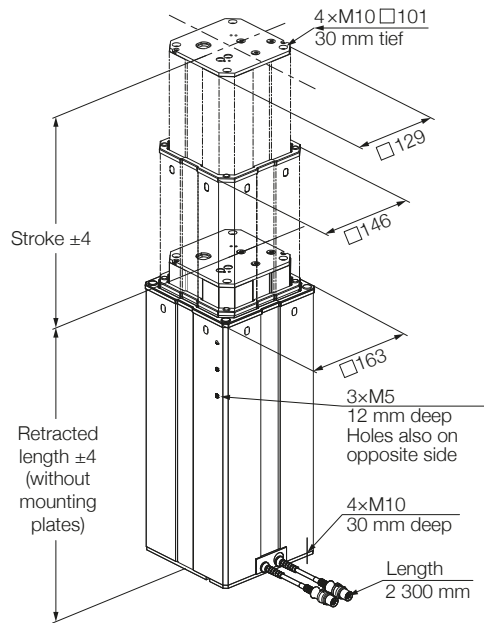

### Bottom fixation plate

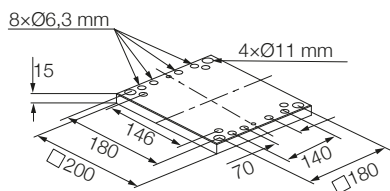

### Controller

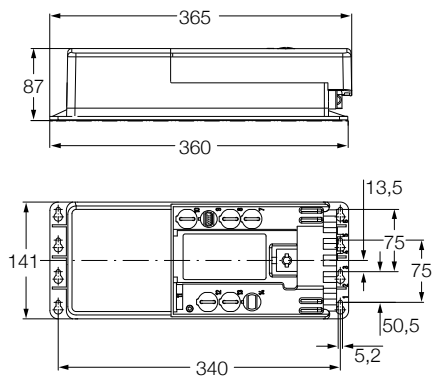

### SBOX

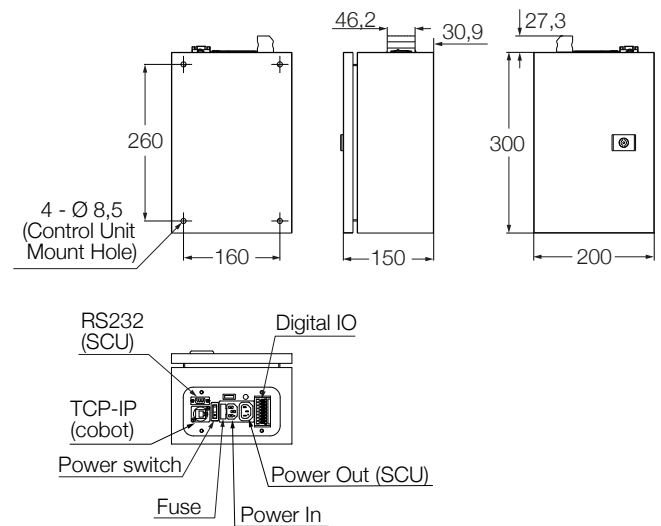

## 9. Appendix

### ⚠ WARNING

This is the extract of the SCU manual chapter **Safety**. For more information please see [SCU operating manual PUB TC-08005](#).

### 9.1 Safety SCU control unit

This section provides an overview of important safety aspects of installing, operating and maintaining this device.

Disregarding this manual and safety regulations specified therein may result in considerable danger and possible serious injury or death or damage to device or equipment.

The SCU control unit was designed and build in accordance with the latest technical standards and accepted rules.

EU-Conformity is documented with the technical documentation.

## 9.2 Use

### 9.2.1 Intended Use

The SCU control unit was designed and built in accordance with the latest technical standards and accepted safety rules.

The intended purpose is described in these instructions.

The authorized use of the SCU control unit is:

**“Control up to six actuators for push- or pull loads”.**

### NOTICE

The control unit can only be parametrized for the actuators of Ewellix. Please contact customer services to find out which actuators are approved for the SCU!

### NOTE

For the operations data, please see [IL-06008-Control units](#) catalogue.

If you use the SCU control unit for any use other that cited, the manufacturer cannot be held the responsibility for defect or damage resulting from this.

It is only intended for interior use and is implemented in medical devices as well as in industrial and construction technology.

Range of environmental conditions:

- Ambient temperature: 5 to 40 °C
- Relative humidity : 5 to 85%
- Atmospheric pressure: 700 hPa to 1 060 hPa
- Use and operate at an altitude of 3000 m (MOPP)
- Overvoltage category II
- Pollution degree classification 2.

### Product life time

The SCU control unit is designed for a service life of 10 years or at least 100 000 cycles of operation per channel.

### User groups

The organization and implementation of the operation manual takes into account the different user groups

To ensure safety, we place requirements on the users of the SCU control unit that must be adhered to under all circumstances. Only persons who meet the requirements are entitled to use the SCU control unit.

We refer to all persons who operate, use, commission the control unit, process it further or pass it on for further processing as user groups. As the requirements of these user groups strongly depend on their role, we distinguish between the following user groups:

The **operating authority** is the contractual partner of the person doing the further processing or the reseller. They can impose legal conditions on the operating authority when purchasing the control unit. The operating authority ensures that the user is instructed in the authorized use of the equipment.

The **processor** is the contractual partner of the reseller or the manufacturer. He assembles the control unit into a total device. He is authorized by the manufacturer of the SCU control unit to use the control unit in accordance with the regulations and has the necessary expert knowledge.

The **technician** has the professional technical training to implement the SCU control unit according to its authorized use. Apart from the chapter on Safety, he is also familiar with the chapter on Special operating modes. He will find the required technical data in the **Appendix** (see [SCU operating manual PUB TC-08005](#).)



The **reseller** forwards the machine. Every other person who uses the SCU control unit we define as an **operator**. The operator must have read the Safety chapter in this manual before using the machine. Moreover, he must be instructed about the normal operation by the operating authority.

## Types of operation

The SCU control unit is exclusively intended for intermittent operation.

## Danger zones

We differentiate between two danger zones that must be observed, depending on user role.

The danger zone covering **persons** includes, aside from the actual user, third persons as well (other personnel, visitors, patients etc.) In case of injury, the operating authority is responsible.

The danger zone **device** comes under the user group Executor and Technician and covers the SCU control unit and all the mounted-on elements.

## 9.2.2 Unintended Use

Any use other than the intended use, or modifications to the device without the manufacturer's written agreement, or operation beyond the technical limits, is considered unauthorized.

See technical operating limits in the technical data of [IL-06008-Control units](#) catalogue and on the label of the SCU.

### NOTE

Any unauthorized use of the device can cause personal injury and property damage. Always adhere to the instructions given in this manual.

The SCU control unit is suitable only for internal use and must not be subjected to weathering, strong UV radiation or explosive atmospheric media. Specific application exemptions are:

- Flammable anesthetic mixture with air
- Flammable anesthetic mixture with oxygen or nitrous oxide
- Increased radiation.

### ⚠ WARNING

#### Risk from misuse.

Any utilization of this device beyond its intended purpose may lead to potentially hazardous situations.

Therefore:

- Strictly adhere to all safety precautions and instructions in this operating manual.
- Do not make this device subject to weather conditions, strong UV rays, corrosive or explosive air media as well as other aggressive media.
- Do not modify, retool or change the structural design or individual components of the actuator.
- Never use the device outside of the technical application and operational limits.

## 9.2.3 Essential performance

Supply electromechanical actuators / pillars by command.

## 9.3 Responsibility of the owner and processor

The device is designed for commercial applications by its owner or processor. The processor is the contracting partner of the reseller or the manufacturer. The processor installs the device in a complete system (application).

The owner or processor of the system is therefore subject to the requirements of the Occupational Health and Safety Act. In addition to the safety instructions in this manual, the owner or processor must do the following concerning these safety and accident prevention guidelines and environmental protection regulations applicable to the site of the system's installation:

- Inform themselves of applicable industrial safety regulations. They must also determine additional hazards that arise due to the specific working conditions prevailing at the site where the device is installed using risk assessment. The risk assessment must be implemented in the form of work instructions for device operation.
- Confirm that the work instructions created for the system, including the device satisfy current legal requirements and must alter the instructions accordingly.
- Clearly regulate and specify the responsibilities for installation, operation, maintenance, and cleaning.
- Ensure that all employees who deal with the device have read and understood this manual.
- Provide personnel with the required protective equipment.
- Provide training for personnel at regular intervals and inform personnel of the hazards.

In addition, the owner or processors must ensure that the device is in adequate working condition. They must do the following:

- Ensure that the maintenance intervals described in these instructions are complied with.
- Have all safety devices inspected regularly for function and completeness.

### 9.3.1 Areas of responsibility

Different areas of responsibility, corresponding to the different user groups, arise.

The Operating Authority has the responsibility for the danger zone covering persons and ensures that only authorized and instructed users work with the SCU control unit. He or she is responsible for the following:

- Determining the persons who may use the SCU control unit (authorized persons).
- Instruction of the users.
- Complying with all relevant legal conditions and regulations.

#### NOTICE

The Operating Authority may only authorize such persons for using the SCU control unit, who conform to the requirements for the user roles.

The **processor** is responsible for:

- Generation of a CE-conformant operation manual of the device in which the SCU control unit has been integrated.
- Adherence to the safety regulations in accordance with this operating manual.

The **technician** is responsible for:

- Observing the manufacturer's instructions and the safe-set-up of interfaces with other equipment.
- Installation and use of the SCU control unit in accordance with its intended purpose-conformant use.
- Installation of optional modules and connecting cables.

The **reseller** is responsible for:

- Passing on this operating manual and the SCU control unit to the executor.
- Passing on of a CE-conformant operating manual and the device in which the SCU control unit has been integrated to the Operating Authority.

The **operator** is responsible for:

- Ensures that nobody is endangered owing to the operation of the SCU control unit.
- Operation of the SCU control unit in normal operation.
- Immediate and appropriate reaction to malfunctions.

## 9.4 Personnel requirements

#### ⚠ WARNING

**Improper installation, operation and maintenance can result in serious injury, death or property damage.**

Use only qualified, instructed, or trained personnel (as described below) who have read, understand and follow these instructions.

### 9.4.1 Qualifications

The following qualifications are specified for different areas of activity listed in this manual:

- **An instructed person (operator):** Instructed by the customer in an orientation session on the assigned tasks and possible dangers arising from in case of improper behavior.
- **Qualified personnel:** Based on their professional training, know-how and experience as well as knowledge of the applicable standards and regulations are able to independently perform assigned work activities and to detect and avoid possible dangers.
- **Professional electrician:** Based on his/her professional training, know-how and experience as well as knowledge of the applicable standards and regulations is able to independently perform work on electrical systems and to detect and avoid possible dangers.  
In addition, the professional electrician has been trained for the special location where he/she works and knows the relevant standards and regulations.

Only persons who can be expected to perform their tasks reliably are permitted as personnel. Persons whose reaction capabilities are impaired, e.g. through the use of drugs, alcohol or medication for example, are not permitted.

## 9.5 Specific dangers

The manufacturer has constructively, and with protective measures, minimized the effects of existing hazards. Pay attention to the residual hazards and potential countermeasures described and the warnings in the following chapters.

### 9.5.1 Residual hazards to people, objects and property

Keep in mind the following residual dangers and the possible countermeasures in handling the SCU control unit.

#### ⚠ DANGER

##### **Danger to life caused by electric current.**

Touching conductive parts causes a direct danger to life. Damage to insulation or individual components can cause danger to life.

Therefore:

- In the event of damage to insulation, switch off the power supply immediately and have the defective parts repaired.
- Work on the electrical system must be carried out only by skilled electricians.
- De-energize the machine for all work on the electrical system.
- Before maintenance, cleaning or repair work, switch off the power supply and perform lockout procedures so it cannot be turned on again.
- Do not bridge fuses or make them ineffective. When changing fuses, make sure you use the correct amperage.
- Keep moisture away from conductive parts. If you do not, this can cause short circuit.

#### ⚠ WARNING

##### **Electrical shock hazard**

Check the mains voltage corresponds to the nominal values on the product label.

- Ensure that power cables cannot become pinched or damaged.
- Warning regarding electrical shock owing to damaged plugs or damaged network cables. Never touch a damaged network plug or a damaged network cable when the SCU control unit is running, since the SCU control unit is supplied with 120 VAC or 230 VAC.
- Ensure, before you pull a defective plug out of the plug socket, that the SCU control unit is disconnected from the power supply.

#### ⚠ WARNING

##### **Unintended, uncontrollable movement**

- Due to a defect of a component, an uncontrollable movement of the connected actuator(s) can occur.
- In worst case RAM or ROM failure can lead to a false or auto motion. This kind of failure has a low failure probability and it occurs in such a way that a motion is started.
- If the button of the hand switch sticks when releasing it and the user doesn't press the button for the opposite direction then an auto motion occurs.

#### ⚠ WARNING

##### **Specific dangers during cleaning or washing the control unit SCU**

The control units are designed to comply with IPX4.

The cleaning or washing with water including chemical additives must be pH-neutral. Excessively acidic or alkaline washing water can destroy metal and plastic components of the control unit.

Manually and mechanically operated high-pressure steam cleaners must not be used. Only isopropyl alcohol cleaning agent may be used for disinfecting by manual wiping.

A SCU control unit must never be washed in a washing machine or other equipment. The control unit would be destroyed by the penetration of liquid.

The plastic housing must be checked periodically (every six months) for mechanical damage (cracks).

#### ⚠ WARNING

Injury due to cracks and related openings in the housing of the actuator and/or its accessories:

If the housing is damaged due to stock, breakage or heavy wear, stop using the device and follow the dismantling instructions.

#### ⚠ CAUTION

Please be aware of damage to people or property as the result of incorrect operation. Incorrect operation can endanger people in the danger zone or objects.

- Before pressing a button on the operating device, ensure that you press the right button.
- Take appropriate measures to ensure that the operating device cannot be operated.

#### ⚠ CAUTION

No function is considered as a safe condition.

#### ⚠ CAUTION

The SCU control unit is only suitable for interior applications and must not be subjected to weathering, strong UV radiation or corrosive or explosive air.

The SCU control unit may only be operated when the safety protective cover is mounted.

#### ⚠ CAUTION

Failure of the control unit due to interruption to the mains power or an electronic defect should not pose any hazard to the patient, to the operator or to the servicing personnel.

Ewellix actuators should be operated in accordance with the application specified on the type label.

The nominal data for the actuators and the control unit must be verified at the same time of installation. The ratings on the data should not be exceeded. If this information is disregarded, the actuator and the control unit will be damaged irreparably. Risk of personal injury remains.

#### ⚠ CAUTION

Any overload on the control unit will trip a temperature switch in the mains transformer. After cooling of the transformer, the thermal protector will reset, so the control unit SCU is ready again to control the actuators.

**⚠ CAUTION****Electric shock hazard**

Take care about damage to the SCU from water sprays. The control unit SCU is splash-proofed according to IPX4. Prevent the SCU from being subjected to water sprays or hosing during the operation time.

**NOTICE**

Prolonged overload will result in irreparable damage to the control unit.

## 9.5.2 Specific dangers SCU with batteries

Replacement batteries should only be ordered from Ewellix, since they are a special type. The old batteries must be properly disposed of. The user's maintenance personnel must be given instructions by the ultimate manufacturer on opening and closing the battery compartment lid and on replacing the batteries.

**⚠ WARNING**

If unintended movements can cause serious injury, additional protective means must be installed to stop or avoid such movements.

**⚠ WARNING**

Disconnection from the mains power supply will not prevent movement of the actuators in case of an electric defect while batteries are connected.

## 9.6 Safety equipment

**⚠ WARNING****Danger due to malfunctioning safety equipment**

For safe operation, be sure all safety equipment is in good working order.

Therefore:

- Always check functionality of safety equipment according to the maintenance plan.
- Never disengage safety equipment.
- Safety equipment may never be by-passed or modified.

## Integration in an emergency-stop system required (for certain applications)

**⚠ WARNING****Electric shock hazard**

The SCU control unit do not have an on/off switch. If required to be switched off, for example in an emergency, the control unit must be disconnected from the power supply. Only this measure will de-energize the control units. Applications where the control units are built in must provide an emergency stop switch or isolation from the power supply on all poles. Additional protective means might be necessary in case of battery options.

The device is only intended for installation into an application or system. It does not have its own operating control elements and does not have an independent emergency-stop-function. Install the device so that it is part of an emergency shut-off system and can be stopped if necessary.

The emergency shut-off system has to be connected in such a way that a disruption of the power supply or the reactivation of the power supply after a power disruption cannot cause a hazardous situation for persons and objects.

The emergency shut-off systems must always be freely accessible.

## 9.7 Safeguard against restart

To secure the SCU control unit against unintentional restart:

1. Pull the power line plug off the control unit from the main supply.

**⚠ DANGER****Life-threatening situation through unauthorized restart**

For work in hazard zones, there is a risk that the power supply is turned on without prior authorization. This presents a life-threatening situation for people in the hazard zone.

Therefore:

- Follow the information concerning the safeguarding against restarting of the power supply in the chapters of [SCU operating manual PUB TC-08005](#).
- Always follow the process to safeguard against a restart as described below.

Protect the SCU control unit against restart:

2. Pull the power line plug out of the power outlet.
3. In case the SCU control unit is equipped with a battery, ensure to remove the battery.

## 9.8 Modification & Information of device

### ⚠ WARNING

To avoid hazardous situations and to ensure optimal performance, do not make any changes or modifications to the device unless they have been specifically authorized by Ewellix.

### 9.8.1 Warning labels

For SCU control units no special warning labels are applied.

### ⚠ WARNING

#### Danger of injury because of illegible symbols

Over the course of time stickers and decals may become dirty or illegible for various reasons.

Therefore:

- Keep any safety, warning and operation related decals in legible condition at all times.
- Replace damaged decals or stickers immediately.

### 9.8.2 Information labels & lights

#### Labels

On the back side of the SCU control unit are two labels (see **figure 30**):

- Type label
- Software parameter label (see **figure 31**).

**Figure 30**

Location of type label and SCU parameter label



**Figure 31**

Example "Smart Control Parameter" (SCP-Label)

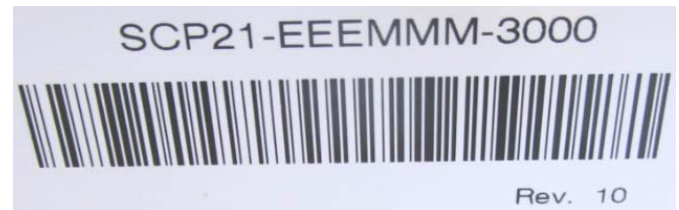

An additional label (inside, under the case cover, see **figure 32**) shows the socket pin assignment inputs / outputs (linear actuators, telescopic pillars, switches, operating elements, battery, etc.)

**Figure 32**

Example SCU socket pin assignment

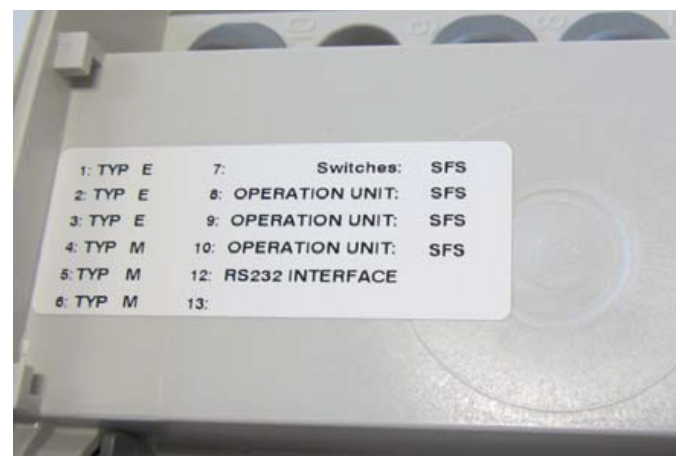

For detailed information about the SCP-label (see **figure 31**) and the corresponding description label of the SCU sockets (see **figure 32**) contact Ewellix business support!

### Power indicator light

The indicator light secures the visualization of the readiness of the control unit SCU (see **figure 33**).

**NOTICE**

The SCU control unit is equipped with a green indicator light LED to indicate ready for normal use.

**Figure 33**

*Power indicator light*



In addition to that a LED on the connected operating element (ex. hand switch) shows the status of the functionality and the status about the SCU and the connected actuators and gives (optional) information about the loading capacity of a used battery.

**CAUTION**

**Push-to-run operation (recommended):**

The connected actuators, pillars operate as long as the button on the hand switch is pressed. A green pilot lamp indicates the actuation. The relevant function (up/down) is determined and triggered by the button actuation.

If the actuator does not have signals to indicate operation, depending on the application, it is recommended to have an operational signal installed in the application.

### Protective Earth, metal pin

The SCU control units SCU5 & SCU9 are defined as class I devices. These models are connected to PE (protection earth) on side of main supply. This PE is also connected to the metal pin next to the main supply connector (see **figure 34**) on the SCU. This bolt pin can also be used to connect the final application to ground (PE) with a protection earth conductor (green/yellow).

**Figure 34**

*Protective earth, metal pin*

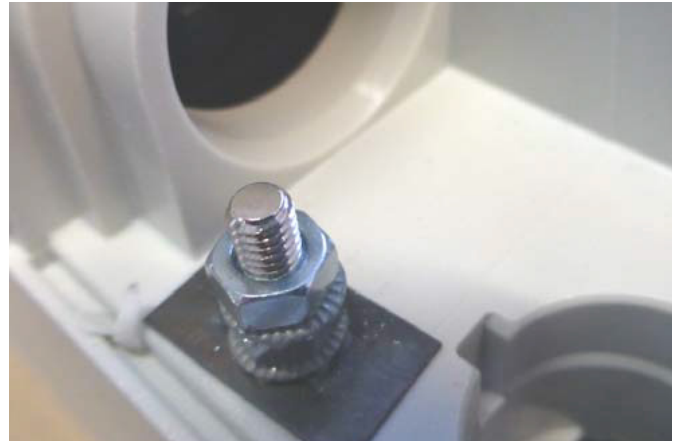

At this pin there is a possibility to connect other devices from the applications to earth ground. This can also help in case of improvements with EMC measurements.

**NOTE**

Take care! The maximum torque for the 6 edge screw is 0,8 Nm.

## 9.9 Manufacturer's declaration of EMC compliance

This section is only mandatory, if the devices are approved and attended for use in medical applications or environment (according IEC60601-1-2 ed. 4) This chapter shows the results and potential about EMC issues.

### 9.9.1 Instructions for use

#### Professional healthcare facility environment

Physician offices, dental offices, clinics, limited care facilities, freestanding surgical centers, freestanding birthing centers, multiple treatment facilities, hospitals (emergency rooms, PATIENT rooms, intensive care, surgery rooms, except near HF SURGICAL EQUIPMENT, an MR system outside a RF shielded room of an ME SYSTEM for magnetic resonance imaging).

#### Essential performance

The essential performance about the SCU control unit is "supply of electro-mechanic actuators and pillars on command". The risk management (Document L5678,0002) identifies the functions about safety of these control units. All features or functions are performed properly. Unacceptable risks for patients, operators or others are performed and assessed to prevent or reduce harm. The follow points identify and describe the EMC-risks about the SCU control unit according the EMC-measurements:

#### Warning against the stacking of equipment

##### WARNING

##### **Stacked with other equipment**

Use of this equipment adjacent to or stacked with other equipment should be avoided because it could result in improper operation. If such use is necessary, this equipment and the other equipment should be observed to verify that they are operating normally.

#### List of cables, length of cables, accessories

##### WARNING

##### **Use of accessories, transducers and cables**

The use of accessories, transducers and tables other than those specified or provided by the manufacturer of this equipment could result in increased electromagnetic emissions or decreased electromagnetic immunity of this equipment and result in improper operation.



**ewellix.com**

© Ewellix

All contents of this publication are the property of Ewellix, and may not be reproduced or given to third parties (even extracts) without permission. Although great care has been taken in the production of this catalog, Ewellix does not take any responsibility for damage or other loss resulting from omissions or typographical errors. The photo may differ slightly in appearance from the actual product. Due to continuous improvements being made in our products, the product's appearance and specifications are subject to change without notice.

**PUB NUM TC-08045/4-EN-June 2023**

Omron and Omron logo are trademarks of the Omron Corporation